

Features

- * Metal Alloy material core provides large saturation current
- * Metallization on ferrite core results in excellent shock resistance and damage-free durability
- * Closed magnetic circuit design reduces leakage flux and Electro Magnetic Interference(EMI)
- * Low DCR decreases power loss,small and slim take up less PCB real estate
- * Automatic production ensures high quality and consistency
- * RoHS compliant and halogen free**



Applications

- * DC/DC converters
- * Digital video cameras, Smart phone, Smart TV, Set top box, Notebook computers
- * Car navigation systems, Televisions
- * VR, AR
- * LED Lighting, LCD displays

Appearance and Dimensions

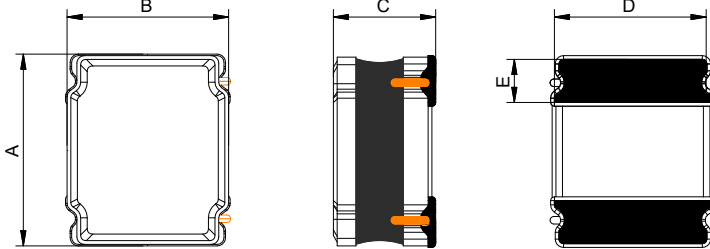

| Dimensions(mm) | | | | | |
|----------------|----------|----------|-----------|----------|----------|
| Series | A | B | C | D | E |
| EMAI-201610S | 2.0±0.20 | 1.6±0.20 | 1.08 max. | 1.6±0.20 | 0.6±0.20 |

Land Pattern Dimensions

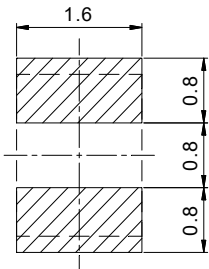

Circuit Diagram

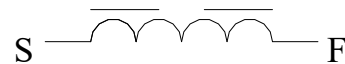

Product Identification

EMAI - 201610 S - 1R0 M

- ① ② ③ ④ ⑤

- ① Product Symbol
- ② Dimensions
- ③ Current Code (S:Standard ; H:High)
- ④ Inductance Value (1R0:1.0μH; 100:10μH)
- ⑤ Inductance Tolerance (K:10% ; M:20% ; N:30%)

苏州隆亿电子科技有限公司

SUZHOU LONGYI ELECTRONIC TECHNOLOGY CO.,LTD.

TEL: +86 512-66322495

<https://www.lyetec.com>

FAX: +86 512-68055173

E-mail: sales@lyetec.com

Electrical Characteristics

| Part No. | Inductance @1MHz/1V | Tolerance | DC Resistance | | Saturation Current | | Heat Rating Current | |
|-------------------|------------------------|-----------|-----------------|-------|--------------------|------|---------------------|------|
| | | | max. | typ. | max. | typ. | max. | typ. |
| Unit | μH | % | Ω | | A | | A | |
| Symbol | L | Tol. | R _{DC} | | I _{SAT} | | I _{RMS} | |
| EMAI-201610S-R24M | 0.24 | 20% | 0.040 | 0.033 | 4.50 | 5.50 | 3.00 | 3.45 |
| EMAI-201610S-R33M | 0.33 | 20% | 0.049 | 0.041 | 4.40 | 5.20 | 2.70 | 3.10 |
| EMAI-201610S-R47M | 0.47 | 20% | 0.049 | 0.041 | 4.06 | 4.70 | 2.70 | 3.10 |
| EMAI-201610S-R56M | 0.56 | 20% | 0.053 | 0.043 | 3.80 | 4.50 | 2.60 | 2.80 |
| EMAI-201610S-R68M | 0.68 | 20% | 0.065 | 0.057 | 3.50 | 4.00 | 2.50 | 2.80 |
| EMAI-201610S-1R0M | 1.00 | 20% | 0.095 | 0.078 | 3.30 | 3.80 | 2.00 | 2.30 |
| EMAI-201610S-1R5M | 1.50 | 20% | 0.130 | 0.110 | 1.95 | 2.30 | 1.70 | 2.00 |
| EMAI-201610S-2R2M | 2.20 | 20% | 0.180 | 0.160 | 1.90 | 2.15 | 1.40 | 1.60 |
| EMA-I201610S-3R3M | 3.30 | 20% | 0.307 | 0.245 | 1.40 | 1.60 | 1.10 | 1.30 |
| EMAI-201610S-4R7M | 4.70 | 20% | 0.425 | 0.370 | 1.10 | 1.40 | 0.90 | 1.00 |
| EMAI-201610S-6R8M | 6.80 | 20% | 0.620 | 0.500 | 0.95 | 1.10 | 0.70 | 0.82 |
| EMAI-201610S-8R2M | 8.20 | 20% | 0.870 | 0.670 | 0.86 | 1.00 | 0.66 | 0.76 |
| EMAI-201610S-100M | 10.0 | 20% | 0.875 | 0.700 | 0.80 | 0.95 | 0.60 | 0.70 |

Remark:

- ※1: All test data is referenced to 20°C ambient.
- ※2: R_{DC}: DC resistance at 20°C.
- ※3: Rated current: I_{SAT} or I_{RMS}, whichever is smaller.
- ※4: Saturation Current: max. Value, DC current at which the inductance drops less than 30% from its value without current;
typ. Value, DC current at which the inductance drops 30% from its value without current.
- ※5: Heat Rating Current: DC current that causes the temperature rise (ΔT) from 20°C ambient,
for max. Value, ΔT < 40°C; for typ. Value, ΔT is approximate 40°C.
- ※6: Specifications subject to change without notice. Please check our website for latest information

Packing specification

Carrier tape dimensions (mm)

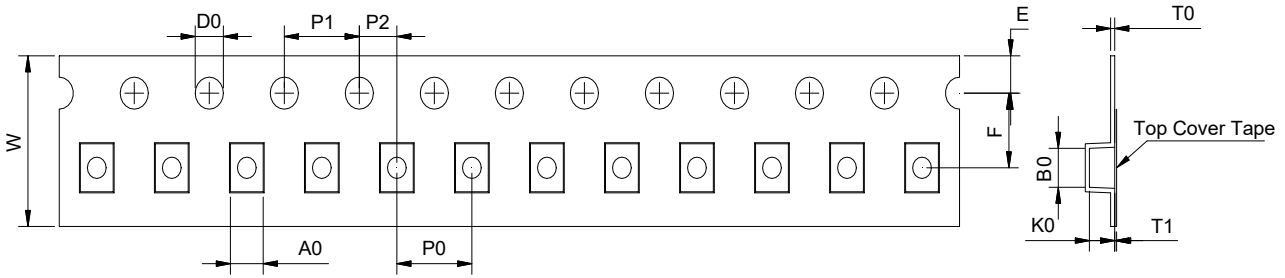

| ITEM | W | P0 | E | F | T0 | T1 | A0 | B0 | K0 | D0 | P1 | P2 |
|-----------|-------|-------|-------|-------|------|------|------|------|------|-------|-------|-------|
| Size(mm) | 8.00 | 4.00 | 1.75 | 3.50 | 0.25 | 0.10 | 2.00 | 2.40 | 1.20 | 1.50 | 4.00 | 2.00 |
| Tolerance | ±0.30 | ±0.10 | ±0.10 | ±0.10 | ref. | max. | typ. | typ. | typ. | ±0.10 | ±0.10 | ±0.10 |

Taping dimensions (mm)

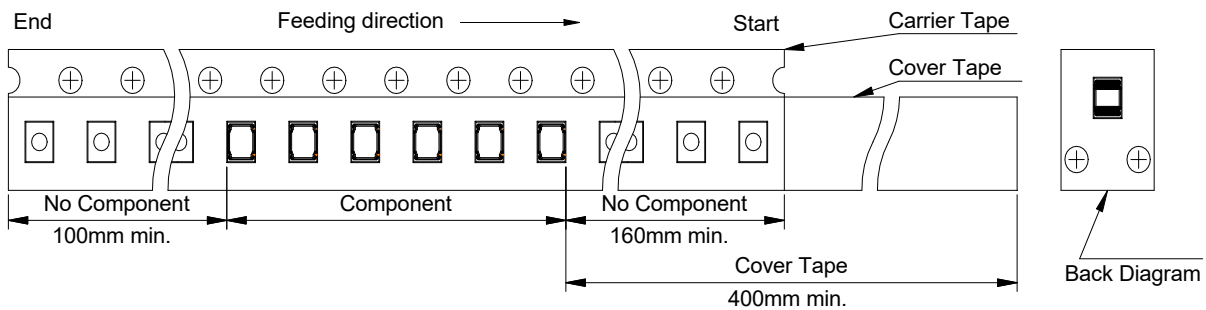

Cover Tape Peel Off Condition

Cover tape peel force shall be 10g to 130g.



Reel Dimensions (mm)

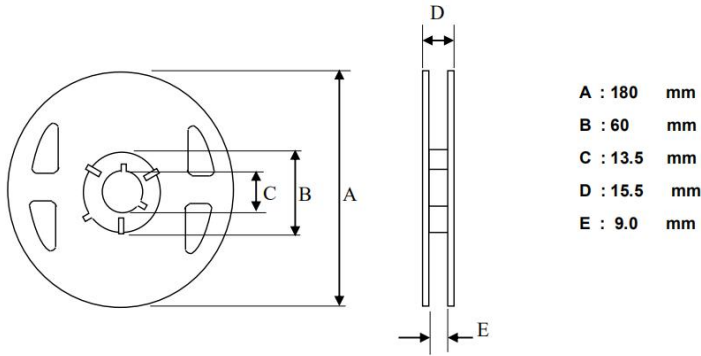

Packing Quantity

| Product Series | Quantity/Reel | Inner Carton Quantity | Outer Carton Quantity |
|----------------|---------------|-----------------------|-----------------------|
| EMAI-201610S | 3000pcs | (3000X6)=18000pcs | (18000X8)=144000pcs |



Recommended Soldering Conditions

Product can be applied to flow and reflow soldering.

(1) Flux, Solder

- ① Use rosin-based flux. Don't use highly acidic flux with halide content exceeding 0.2wt% (chlorine conversion value).
- ② Use Sn solder.

(2) Flow soldering conditions

- ① Pre-heating should be in such a way that the temperature difference between solder and product surface is limited to 150°C max. Cooling into solvent after soldering also should be in such a way that temperature difference is limited to 100°C max. Unwrought pre-heating may cause cracks on the product, resulting in the deterioration of products quality.
- ② Standard soldering profile.



| | |
|--------------------|-----------------------|
| Pre-heating | 150°C, 1 minute min |
| Peak | 260°C, 10 seconds max |

(3) Reflow soldering conditions

Classification Reflow Profile for SMT components:

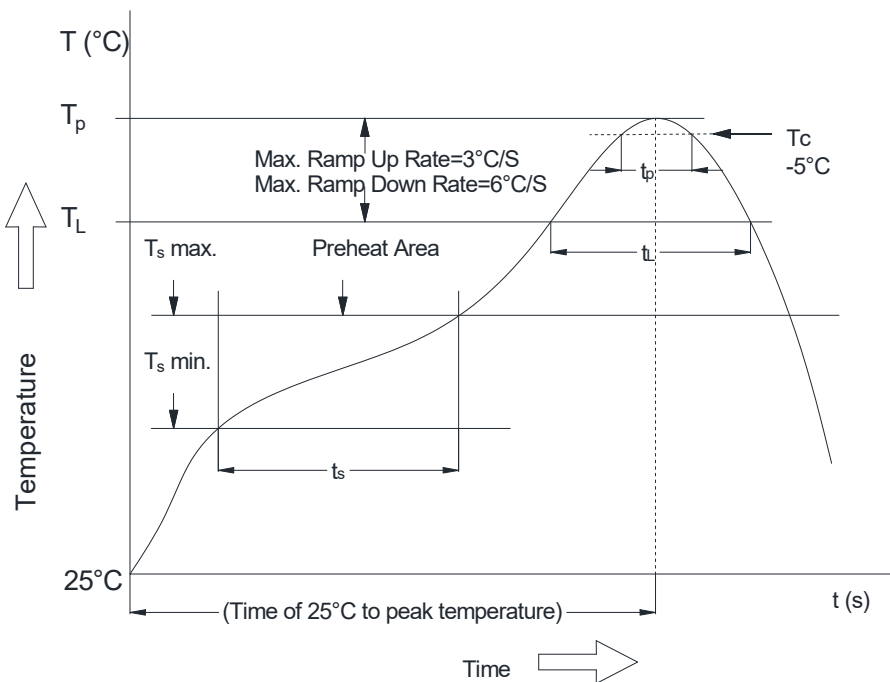

Classification Reflow Soldering Profile:

| Profile Feature | | Lead-Free Assembly |
|--|-----------------------------|--------------------|
| Average Ramp-Up Rate (Ts max. to Tp) | | 3°C/second max. |
| Preheat | - Temperature Min (Ts min.) | 150°C |
| | - Temperature Max (Ts max.) | 200°C |
| | - Time (Ts min to Ts max.) | 60-120 seconds |
| Time maintained above | - Temperature (TL) | 217°C |
| | - Time (tL) | 60-150 seconds |
| Peak/Classification Temperature (Tp) | | see table below |
| Peak/Classification Time (Tp) | | 3-4 seconds |
| Time within 5 °C of actual Peak Temperature (tp) | | 20-30 seconds |
| Ramp-Down Rate | | 6°C/second max. |
| Time 25 °C to Peak Temperature | | 8 minutes max. |

Note 1: All temperatures refer to topside of the package, measured on the package body surface.

2: Refer to IPC/ JEDEC J-STD-020E

Package Classification Reflow Temperature:

| Properties | Volume mm ³ <350 | Volume mm ³ 350-2000 | Volume mm ³ >2000 |
|---|--------------------------------|------------------------------------|---------------------------------|
| PB-Free Assembly Package Thickness < 1.6 mm | 260°C | 260°C | 260°C |
| PB-Free Assembly Package Thickness 1.6mm-2.5 mm | 260°C | 250°C | 245°C |
| PB-Free Assembly Package Thickness ≥2.5 mm | 250°C | 245°C | 245°C |

Refer to IPC/ JEDEC J-STD-020E

(4) The method on Re-work with using the iron:

The following conditions must be strictly followed when using a soldering iron

| | |
|-----------------------|-----------------|
| Pre-heating | 150°C, 1 minute |
| Tip temperature | 280°C max |
| Soldering iron output | 20w max |
| End of soldering iron | φ1mm max |
| Soldering time | 3 seconds max |

Products Storage

(1) Storage period

Products which inspected in LYEC over 12 months ago should be examined and used, which can be confirmed with inspection No. marked on the container. Solderability should be checked if this period is exceeded.

(2) Storage conditions

Products should be storage in the warehouse on the following conditions:

Temperature: Less than 40°C

Humidity : Less than 75% relative and humidity

No rapid change on temperature and humidity

- (3) Don't keep products in corrosive gases such as sulfur, chlorine gas or acid, or it may cause oxidization of electrode, resulting in poor solderability.
- (4) Products should be storage on the palette for the prevention of the influence from humidity, dust and so on.
- (5) Products should be storage in the warehouse without heat shock, vibration, direct sunlight and so on.
- (6) Products should be storage under the airtight packaged condition.