

Features

- * High current, low DCR, high efficiency.
- * Very low acoustic noise and very low leakage flux noise.
- * AEC-Q200 qualified
- * 100% Lead(Pb)-Free and RoHS compliant.
- * Operating temperature: -55 to +155 °C (including self-temperature rise)

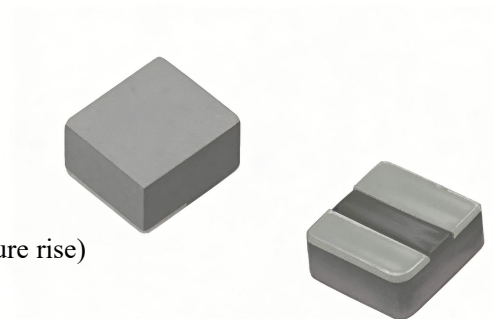

Applications

- * ADAS
- * Headlamps, tail lamps and interior lighting
- * HVAC
- * Doors, window lift and seat control
- * Audio subsystem, Digital instrument cluster, In-Vehicle Infotainment and navigation

Appearance and Dimensions

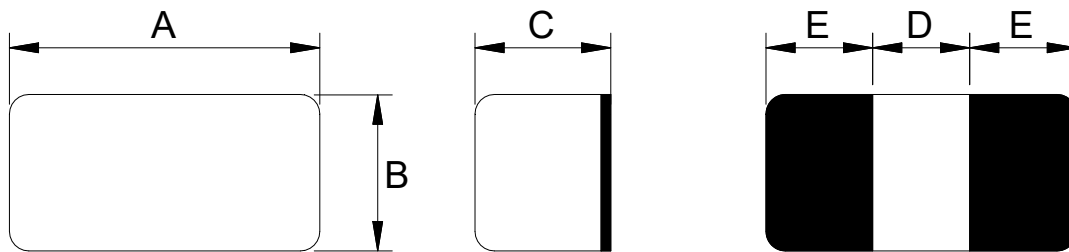

| Dimensions(mm) | | | | | |
|----------------|---------|---------|----------|----------|-----------|
| Series | A | B | C | D | E |
| VMDT-160808 | 1.6±0.3 | 0.8±0.3 | 0.7±0.10 | 0.5±0.30 | 0.55±0.30 |

Land Pattern Dimensions

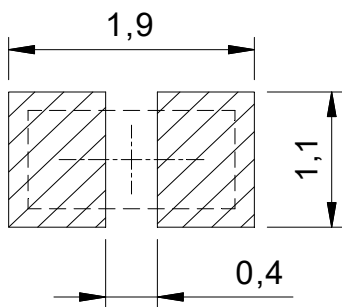

Circuit Diagram

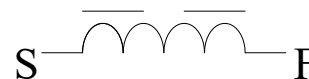

Product Identification

VMDT - 160808 - 1R0 M

① ② ③ ④

- ① Product Symbol
- ② Dimensions
- ③ Inductance Value (1R0:1.0μH)
- ④ Inductance Tolerance (M:20%)

苏州隆亿电子科技有限公司

SUZHOU LONGYI ELECTRONIC TECHNOLOGY CO.,LTD.

TEL: +86 512-66322495

<https://www.lyetec.com>

FAX: +86 512-68055173

E-mail: sales@lyetec.com

Electrical Characteristics

| Part No. | Inductance @100KHz/1V | Tolerance | DC Resistance | | Saturation Current | | Heat Rating Current | |
|------------------|--------------------------|-----------|-----------------|------|--------------------|------|---------------------|------|
| | | | max. | typ. | max. | typ. | max. | typ. |
| Unit | μH | % | mΩ | | A | | A | |
| Symbol | L | Tol. | R _{DC} | | I _{SAT} | | I _{RMS} | |
| VMDT-160808-R22M | 0.22 | ±20 | 40.0 | 33.0 | 5.00 | 5.50 | 3.00 | 3.40 |
| VMDT-160808-R47M | 0.47 | ±20 | 100 | 80.0 | 4.20 | 4.70 | 2.50 | 2.80 |
| VMDT-160808-R56M | 0.56 | ±20 | 110 | 85.0 | 3.60 | 4.10 | 2.20 | 2.40 |
| VMDT-160808-R68M | 0.68 | ±20 | 138 | 115 | 3.00 | 3.30 | 2.00 | 2.20 |
| VMDT-160808-1R0M | 1.00 | ±20 | 200 | 180 | 2.60 | 3.00 | 1.80 | 2.10 |

Remark:

※1:All test data is referenced to 20°C ambient.

※2:R_{DC}:DC resistance at 20°C.

※3:Rated current:I_{SAT} or I_{RMS}, whichever is smaller.

※4:Saturation Current: typ. Value, DC current at which the inductance drops 30% from its value without current.

※5:Heat Rating Current 20°C:DC current that causes the temperature rise (ΔT) from 25°C ambient.For typ. Value, ΔT is approximate 20°C.

Heat Rating Current 40°C:DC current that causes the temperature rise (ΔT) from 25°C ambient.For typ. Value, ΔT is approximate 40°C.

※6:Specifications subject to change without notice. Please check our website for latest information.

Typical Electrical Characteristics

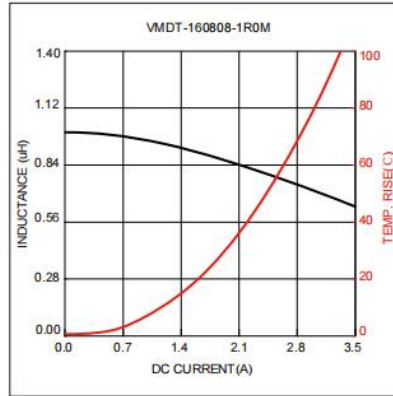
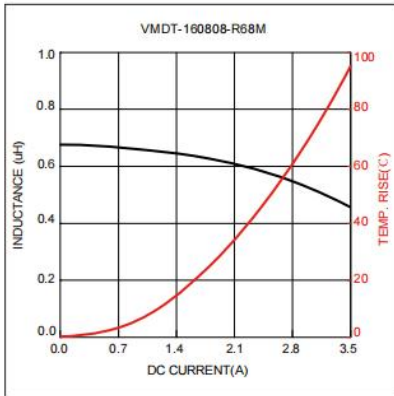
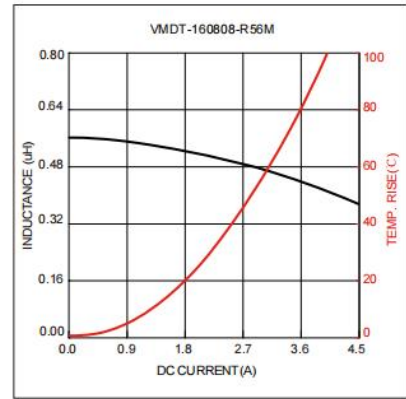
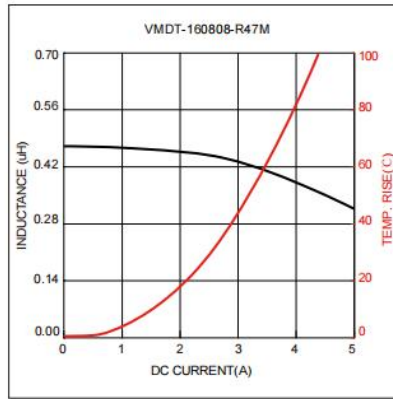
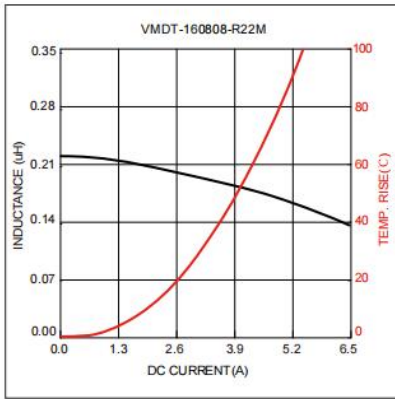

Packing specification

Carrier tape dimensions (mm)

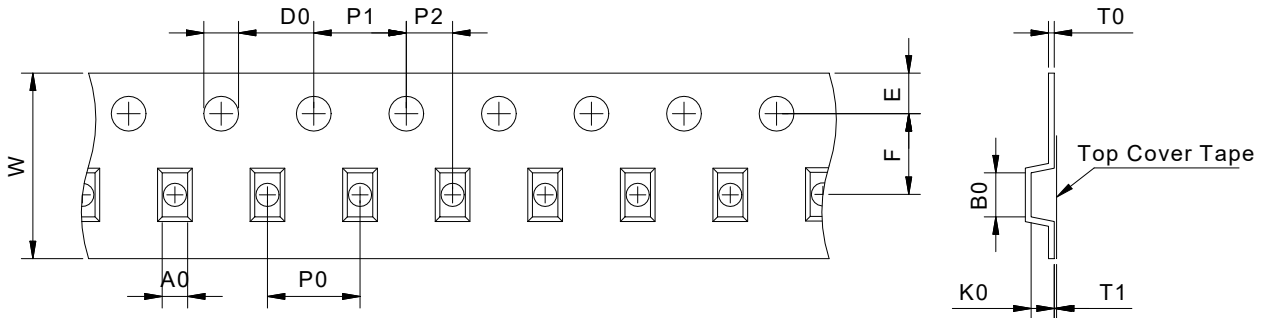

| ITEM | W | P0 | E | F | T0 | T1 | A0 | B0 | K0 | D0 | P1 | P2 |
|-----------|-------|-------|-------|-------|------|------|------|------|------|-------|-------|-------|
| Size(mm) | 8.00 | 4.00 | 1.75 | 3.50 | 0.25 | 0.10 | 1.1 | 1.9 | 1.0 | 1.50 | 4.00 | 2.00 |
| Tolerance | ±0.30 | ±0.10 | ±0.10 | ±0.10 | ref. | max. | typ. | typ. | typ. | ±0.10 | ±0.10 | ±0.10 |

Taping dimensions (mm)

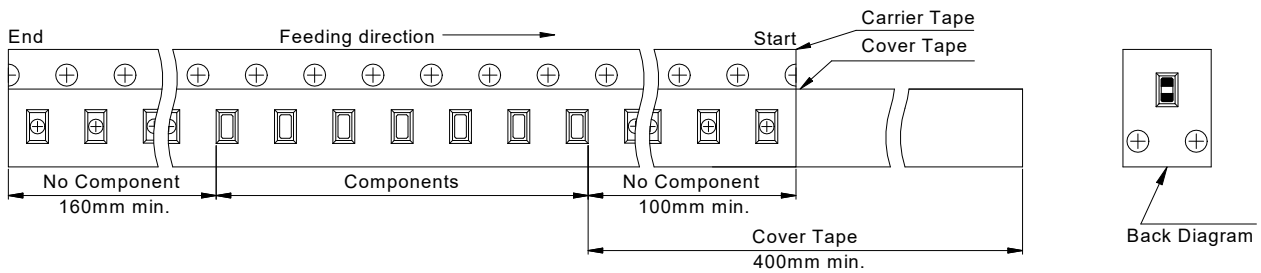

Cover Tape Peel Off Condition

Cover tape peel force shall be 10g to 130g.

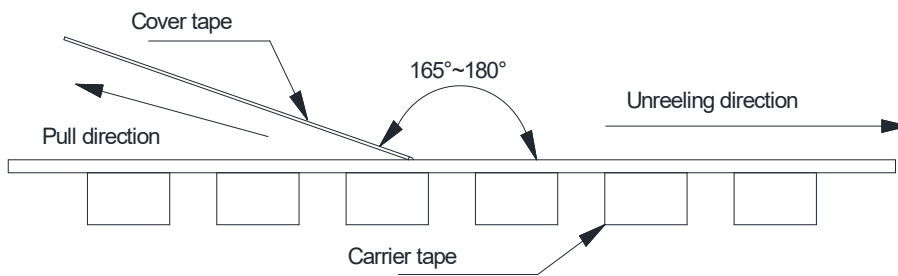

Reel Dimensions (mm)

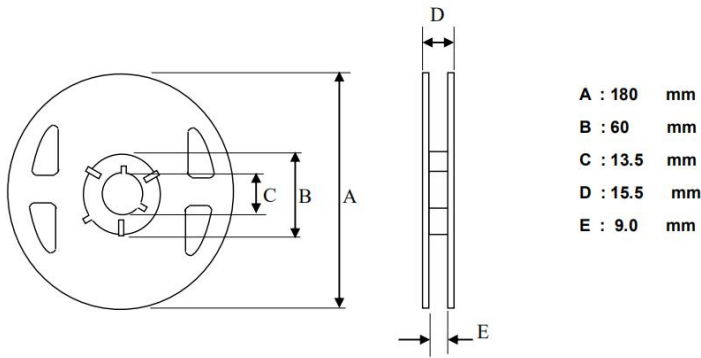

Packing Quantity

| Product Series | Quantity/Reel | Inner Carton Quantity | Outer Carton Quantity |
|----------------|---------------|-----------------------|-----------------------|
| VMDT-160808 | 3000pcs | (3000X6)=18000pcs | (18000X8)=144000pcs |

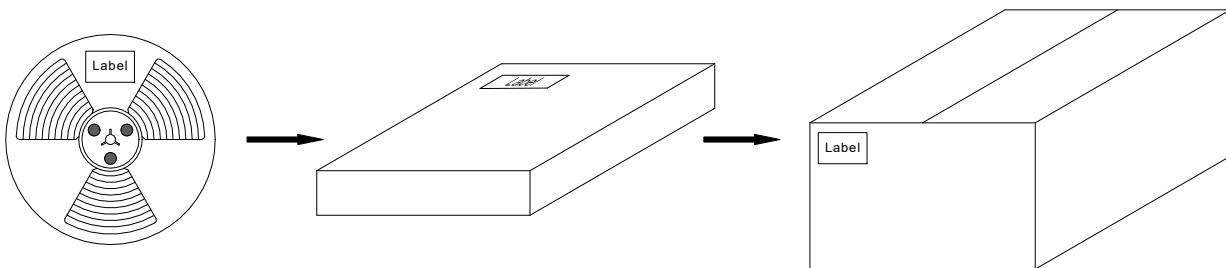

Recommended Soldering Conditions

Product can be applied to flow and reflow soldering.

(1) Flux, Solder

- ① Use rosin-based flux. Don't use highly acidic flux with halide content exceeding 0.2wt% (chlorine conversion value).
- ② Use Sn solder.

(2) Flow soldering conditions

- ① Pre-heating should be in such a way that the temperature difference between solder and product surface is limited to 150°C max. Cooling into solvent after soldering also should be in such a way that temperature difference is limited to 100°C max. Unwrought pre-heating may cause cracks on the product, resulting in the deterioration of products quality.
- ② Standard soldering profile.

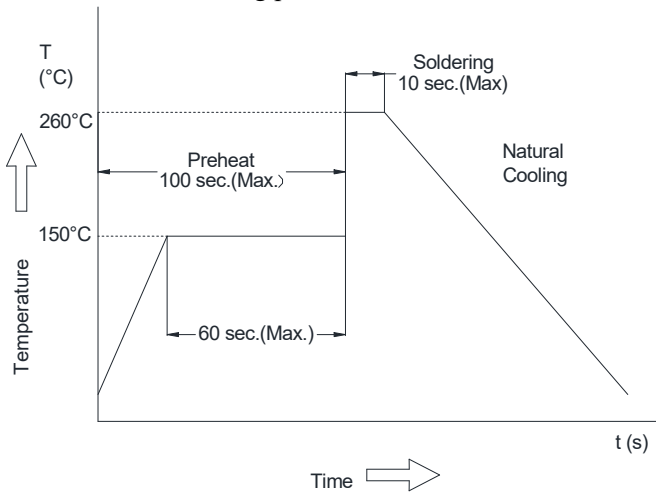

(3) Reflow soldering conditions

Classification Reflow Profile for SMT components:

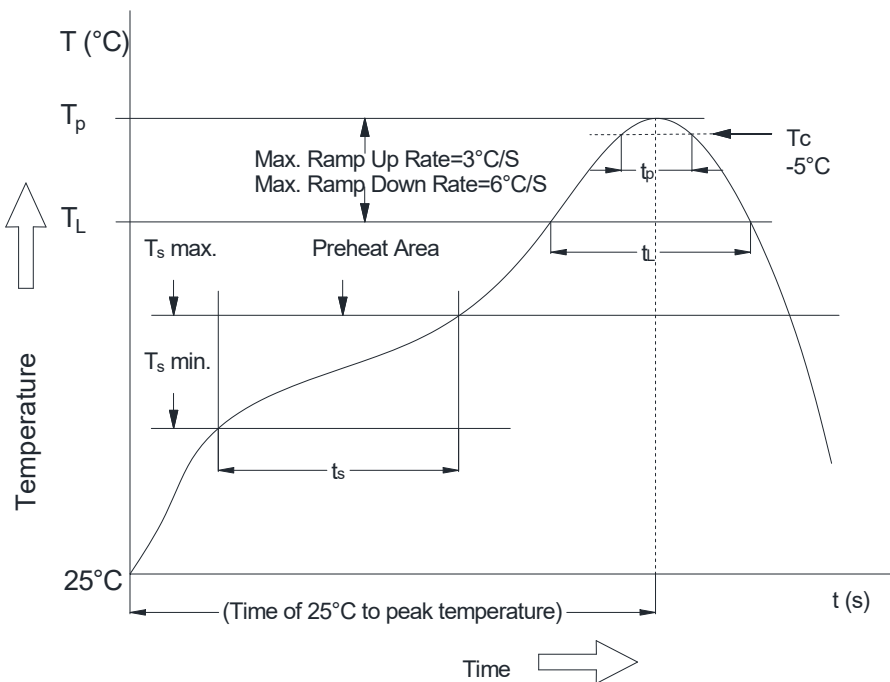

Classification Reflow Soldering Profile:

| Profile Feature | | Lead-Free Assembly |
|--|-----------------------------|--------------------|
| Average Ramp-Up Rate (Ts max. to Tp) | | 3°C/second max. |
| Preheat | - Temperature Min (Ts min.) | 150°C |
| | - Temperature Max (Ts max.) | 200°C |
| | - Time (Ts min to Ts max.) | 60-120 seconds |
| Time maintained above | - Temperature (TL) | 217°C |
| | - Time (tL) | 60-150 seconds |
| Peak/Classification Temperature (Tp) | | see table below |
| Peak/Classification Time (Tp) | | 3-4 seconds |
| Time within 5 °C of actual Peak Temperature (tp) | | 20-30 seconds |
| Ramp-Down Rate | | 6°C/second max. |
| Time 25 °C to Peak Temperature | | 8 minutes max. |

Note 1: All temperatures refer to topside of the package, measured on the package body surface.

2: Refer to IPC/ JEDEC J-STD-020E

Package Classification Reflow Temperature:

| Properties | Volume mm ³ <350 | Volume mm ³ 350-2000 | Volume mm ³ >2000 |
|---|--------------------------------|------------------------------------|---------------------------------|
| PB-Free Assembly Package Thickness < 1.6 mm | 260°C | 260°C | 260°C |
| PB-Free Assembly Package Thickness 1.6mm-2.5 mm | 260°C | 250°C | 245°C |
| PB-Free Assembly Package Thickness ≥2.5 mm | 250°C | 245°C | 245°C |

Refer to IPC/ JEDEC J-STD-020E

(4) The method on Re-work with using the iron:

The following conditions must be strictly followed when using a soldering iron

| | |
|-----------------------|-----------------|
| Pre-heating | 150°C, 1 minute |
| Tip temperature | 280°C max |
| Soldering iron output | 20w max |
| End of soldering iron | φ1mm max |
| Soldering time | 3 seconds max |

Products Storage

(1) Storage period

Products which inspected in LYEC over 12 months ago should be examined and used, which can be confirmed with inspection No. marked on the container. Solderability should be checked if this period is exceeded.

(2) Storage conditions

Products should be storage in the warehouse on the following conditions:

Temperature: Less than 40°C

Humidity : Less than 75% relative and humidity

No rapid change on temperature and humidity

- (3) Don't keep products in corrosive gases such as sulfur, chlorine gas or acid, or it may cause oxidization of electrode, resulting in poor solderability.
- (4) Products should be storage on the palette for the prevention of the influence from humidity, dust and so on.
- (5) Products should be storage in the warehouse without heat shock, vibration, direct sunlight and so on.
- (6) Products should be storage under the airtight packaged condition.