

## Features

- \* Internal silver printed layers and magnetic shielded structures to minimize crosstalk
- \* Can be used in a wide range of frequency (from dozens of MHz to hundreds of MHz) to suppress EMI
- \* Three types material and wide range of impedance values for various applications

## Applications

- \* Noise suppression for low speed signal of electric equipments such as computers and peripheral devices, DVD cameras, LCD TVs, communication equipments, OA equipments, etc.

## Appearance and Dimensions

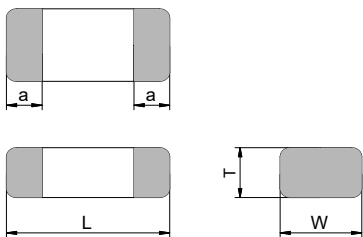

| Dimensions(mm) |          |          |          |           |
|----------------|----------|----------|----------|-----------|
| Series         | L        | W        | T        | a         |
| EGBY060303     | 0.6±0.05 | 0.3±0.05 | 0.3±0.05 | 0.15±0.05 |

## Land Pattern Dimensions

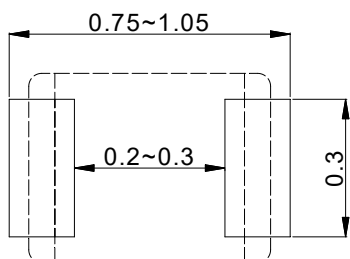

## Circuit Diagram

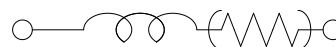

## Product Identification

EGBY 060303 T - 100 Y - N

① ② ③ ④ ⑤ ⑥

- ① Product Symbol
- ② Dimensions
- ③ Packaging (Tape)
- ④ Impedance Value (100:10Ω; 102:1000Ω)
- ⑤ Impedance Tolerance (Y:±25%)
- ⑥ Lead Free

### Electrical Characteristics

| Part No.           | Impedance<br>100MHz | Tol. | DC<br>Resistance<br>max. | Rated<br>Current<br>max. |
|--------------------|---------------------|------|--------------------------|--------------------------|
| Unit               | $\Omega$            | %    | $\Omega$                 | mA                       |
| Symbol             | Z                   | -    | R <sub>DC</sub>          | I <sub>RMS</sub>         |
| EGBY060303T-100Y-N | 10                  | ±25  | 0.10                     | 500                      |
| EGBY060303T-600Y-N | 60                  | ±25  | 0.40                     | 200                      |
| EGBY060303T-700Y-N | 70                  | ±25  | 0.40                     | 200                      |
| EGBY060303T-750Y-N | 75                  | ±25  | 0.40                     | 200                      |
| EGBY060303T-800Y-N | 80                  | ±25  | 0.40                     | 200                      |
| EGBY060303T-121Y-N | 120                 | ±25  | 0.50                     | 200                      |
| EGBY060303T-241Y-N | 240                 | ±25  | 0.80                     | 200                      |
| EGBY060303T-471Y-N | 470                 | ±25  | 1.40                     | 200                      |
| EGBY060303T-601Y-N | 600                 | ±25  | 1.50                     | 100                      |
| EGBY060303T-102Y-N | 1000                | ±25  | 2.50                     | 100                      |

#### Remark:

- ※1: All test data is referenced to 20°C ambient.
- ※2: Rated current: I<sub>SAT</sub> or I<sub>RMS</sub>, whichever is smaller.
- ※3: Saturation Current: max. Value, DC current at which the inductance drops less than 30% from its value without current;  
typ. Value, DC current at which the inductance drops 30% from its value without current.
- ※4: Temperature Rise Current: DC current that causes the temperature rise ( $\Delta T$ ) from 20°C ambient.  
For max. Value,  $\Delta T < 40^\circ\text{C}$ ; for typ. Value,  $\Delta T$  is approximate 40°C.
- ※5: □ specify the inductance tolerance, Y: ±25%.
- ※6: Specifications subject to change without notice. Please check our website for latest information.
- ※7: Absolute maximum voltage: DC 25V.
- ※8: The following product series will refer to the above 7 points and will not be separately noted.

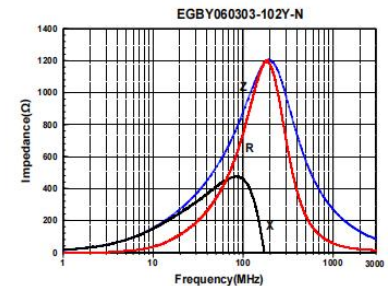
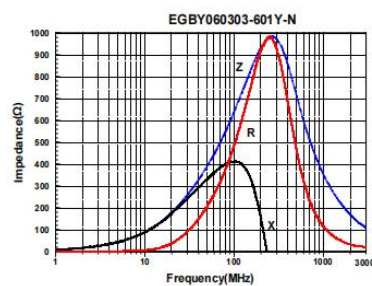
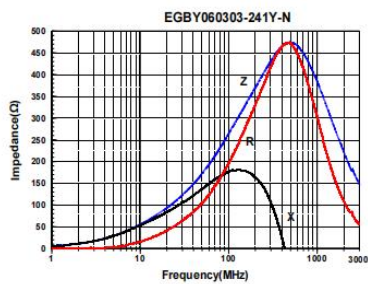
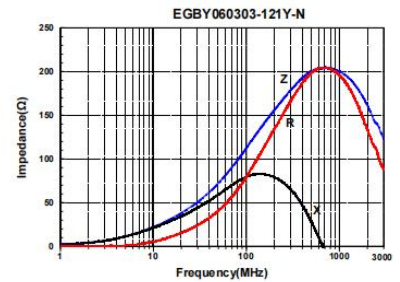
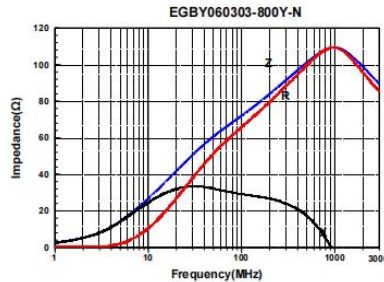
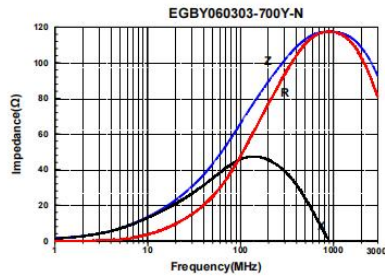
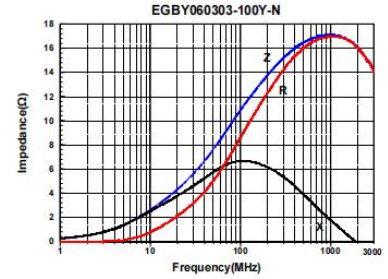
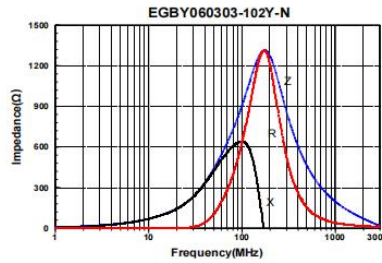
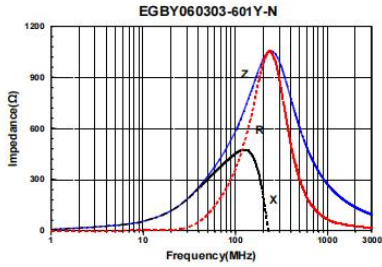
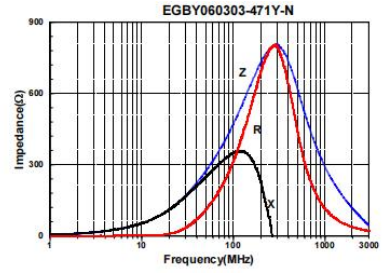
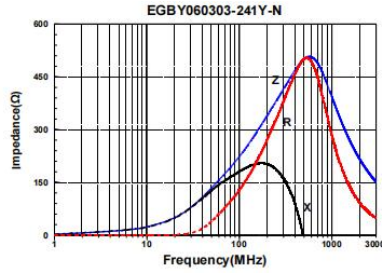
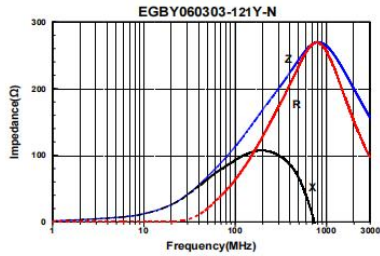
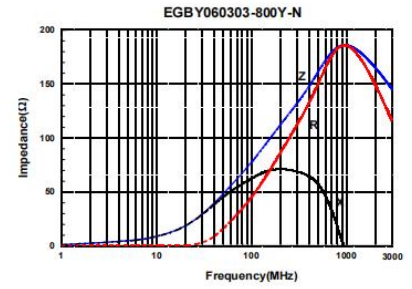
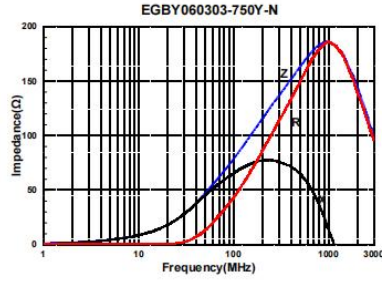
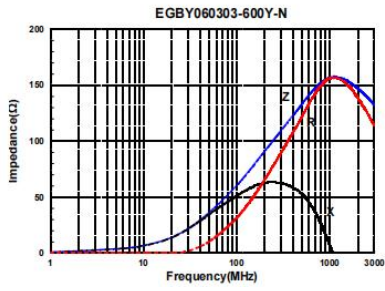

## Packing specification

### Carrier tape dimensions (mm)

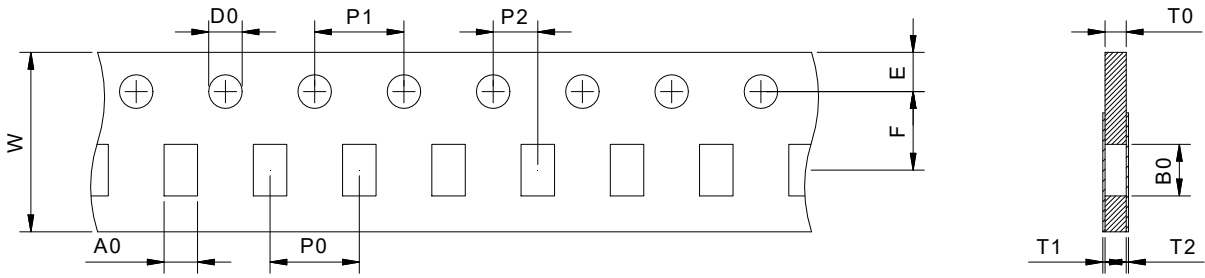

| ITEM      | W          | P0         | E          | F          | T0   | T1   | T2   | A0   | B0   | D0         | P1         | P2         |
|-----------|------------|------------|------------|------------|------|------|------|------|------|------------|------------|------------|
| Size(mm)  | 8.0        | 4.0        | 1.75       | 3.50       | 0.45 | 0.10 | 0.10 | 0.38 | 0.67 | 1.50       | 4.00       | 2.00       |
| Tolerance | $\pm 0.30$ | $\pm 0.10$ | $\pm 0.10$ | $\pm 0.10$ | ref. | max. | max. | typ. | typ. | $\pm 0.10$ | $\pm 0.10$ | $\pm 0.10$ |

### Taping dimensions (mm)

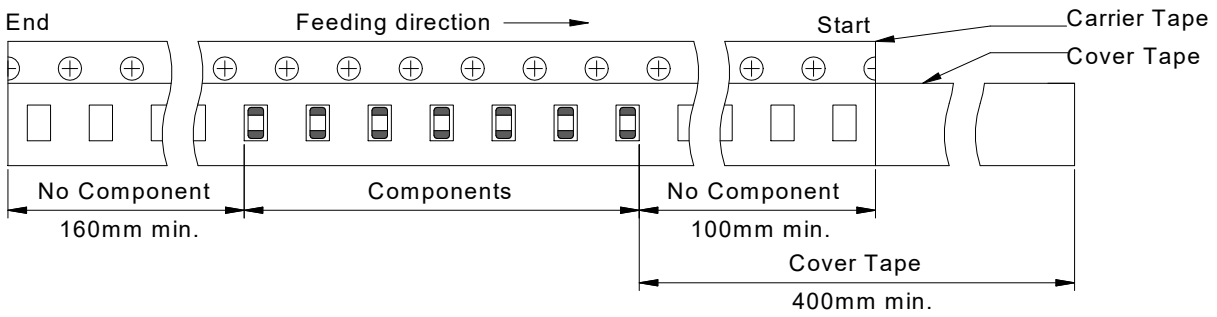

### Cover Tape Peel Off Condition

Cover tape peel force shall be 10g to 130g.

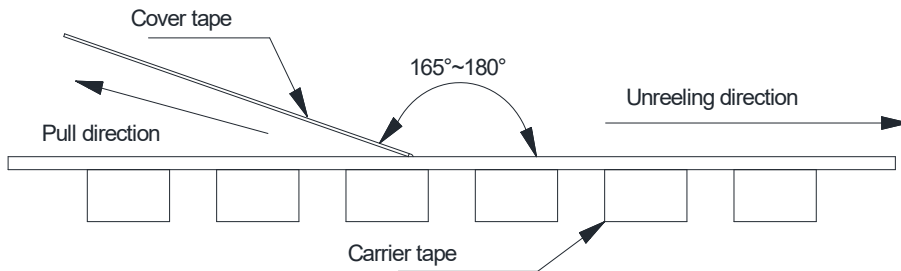

### Reel Dimensions (mm)

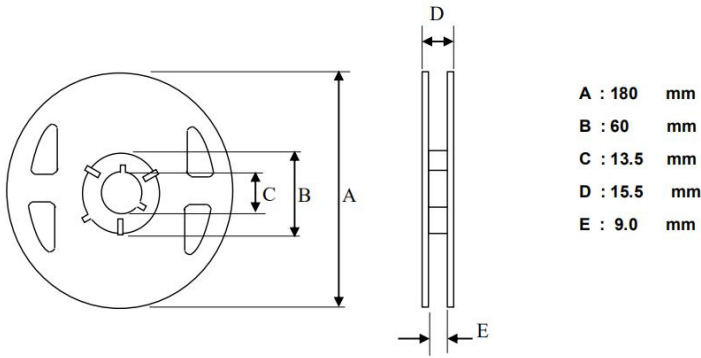

### Packing Quantity

| Product Series | Quantity/Reel | Inner Carton Quantity | Outer Carton Quantity |
|----------------|---------------|-----------------------|-----------------------|
| EGBY060303     | 15000pcs      | (15000X6)=90000pcs    | (90000X3)=270000pcs   |

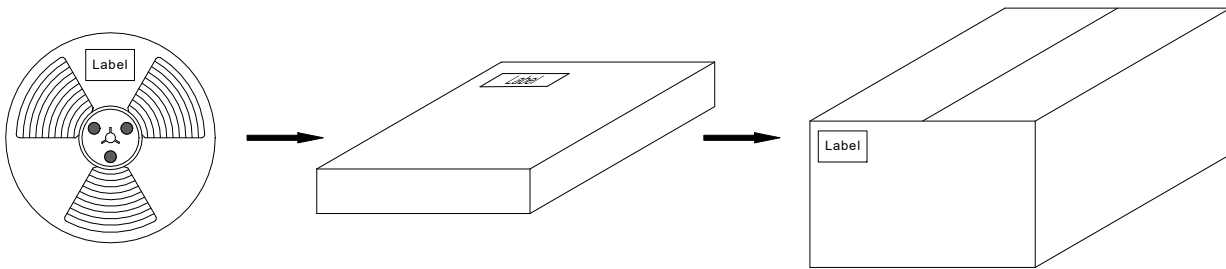

## Recommended Soldering Conditions

Product can be applied to flow and reflow soldering.

### (1) Flux, Solder

① Use rosin-based flux. Don't use highly acidic flux with halide content exceeding 0.2wt% (chlorine conversion value).

② Use Sn solder.

### (2) Flow soldering conditions

① Pre-heating should be in such a way that the temperature difference between solder and product surface is limited to 150°C max. Cooling into solvent after soldering also should be in such a way that temperature difference is limited to 100°C max. Unwrought pre-heating may cause cracks on the product, resulting in the deterioration of products quality.

② Standard soldering profile.

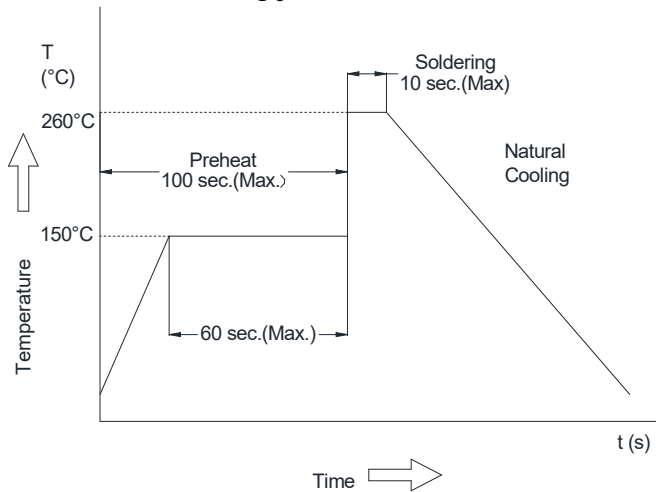

|                    |                       |
|--------------------|-----------------------|
| <b>Pre-heating</b> | 150°C, 1 minute min   |
| <b>Peak</b>        | 260°C, 10 seconds max |

### (3) Reflow soldering conditions

Classification Reflow Profile for SMT components:

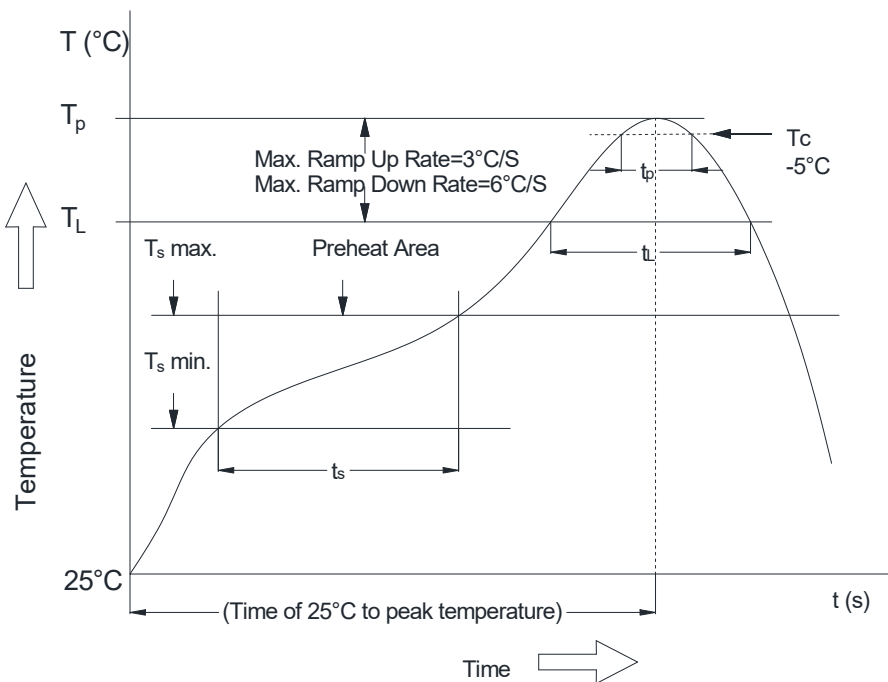

Classification Reflow Soldering Profile:

| Profile Feature                                  |                             | Lead-Free Assembly |
|--|-----------------------------|--------------------|
| Average Ramp-Up Rate (Ts max. to Tp)             |                             | 3°C/second max.    |
| Preheat  | - Temperature Min (Ts min.) | 150°C              |
|  | - Temperature Max (Ts max.) | 200°C              |
|  | - Time (Ts min to Ts max.)  | 60-120 seconds     |
| Time maintained above                            | - Temperature (TL)          | 217°C              |
|  | - Time (tL)                 | 60-150 seconds     |
| Peak/Classification Temperature (Tp)             |                             | see table below    |
| Peak/Classification Time (Tp)                    |                             | 3-4 seconds        |
| Time within 5 °C of actual Peak Temperature (tp) |                             | 20-30 seconds      |
| Ramp-Down Rate                                   |                             | 6°C/second max.    |
| Time 25 °C to Peak Temperature                   |                             | 8 minutes max.     |

Note 1: All temperatures refer to topside of the package, measured on the package body surface.

2: Refer to IPC/ JEDEC J-STD-020E

Package Classification Reflow Temperature:

| Properties  | Volume mm <sup>3</sup><br><350 | Volume mm <sup>3</sup><br>350-2000 | Volume mm <sup>3</sup><br>>2000 |
|---|--------------------------------|------------------------------------|---------------------------------|
| PB-Free Assembly   Package Thickness < 1.6 mm     | 260°C                          | 260°C                              | 260°C                           |
| PB-Free Assembly   Package Thickness 1.6mm-2.5 mm | 260°C                          | 250°C                              | 245°C                           |
| PB-Free Assembly   Package Thickness ≥2.5 mm      | 250°C                          | 245°C                              | 245°C                           |

Refer to IPC/ JEDEC J-STD-020E

(4) The method on Re-work with using the iron:

The following conditions must be strictly followed when using a soldering iron

|                       |                 |
|-----------------------|-----------------|
| Pre-heating           | 150°C, 1 minute |
| Tip temperature       | 280°C max       |
| Soldering iron output | 20w max         |
| End of soldering iron | φ1mm max        |
| Soldering time        | 3 seconds max   |

## Products Storage

(1) Storage period

Products which inspected in LYEC over 12 months ago should be examined and used, which can be confirmed with inspection No. marked on the container. Solderability should be checked if this period is exceeded.

(2) Storage conditions

Products should be storage in the warehouse on the following conditions:

Temperature: Less than 40°C

Humidity : Less than 75% relative and humidity

No rapid change on temperature and humidity

- (3) Don't keep products in corrosive gases such as sulfur, chlorine gas or acid, or it may cause oxidization of electrode, resulting in poor solderability.
- (4) Products should be storage on the palette for the prevention of the influence from humidity, dust and so on.
- (5) Products should be storage in the warehouse without heat shock, vibration, direct sunlight and so on.
- (6) Products should be storage under the airtight packaged condition.