

Features

- *Semi-Shielded construction
- *Magnetic-resin shielded Construction reduces buzz noise ultra-low levels
- *Metallization on ferrite core results in excellent shock resistance and damage-free durability
- *Closed magnetic circuit design reduces leakage flux and Electro Magnetic interference (EMI)
- *30% Higher current rating than conventional inductors of equal size
- *Takes up less PCB real estate and save more power.....

Applications

- * DC/DC converters
- * Digital video cameras, Smart phone, Smart TV, Set top box, Notebook computers
- * Car navigation systems, Televisions
- * VR, AR
- * LED Lighting, LCD displays



Appearance and Dimensions

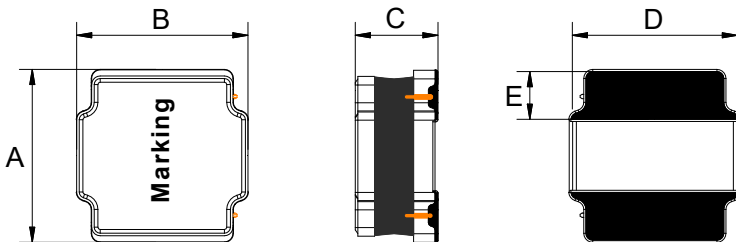

Dimensions(mm)					
Series	A	B	C	D	E
ENR-4018	4.0±0.20	4.0±0.20	1.85max.	3.30±0.2	1.00±0.20

Land Pattern Dimensions

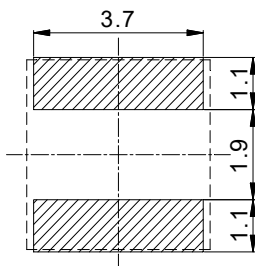

Circuit Diagram



Product Identification

ENR - 4018 - 2R2 M

- ① ② ③ ④

- ① Product Symbol
- ② Dimensions
- ③ Inductance Value (2R2:2.2μH; 220:22μH; 221:220μH)
- ④ Inductance Tolerance (M:20% ; N:30%)

Electrical Characteristics

Part No.	Inductance @100KHz/1V	Tolerance	DC Resistance		Saturation Current		Heat Rating Current	
			max.	typ.	max.	typ.	max.	typ.
Unit	μH	%	Ω		A		A	
Symbol	L	Tol.	R _{DC}		I _{SAT}		I _{RMS}	
ENR-4018-R24N	0.24	±30	0.018	0.011	6.00	6.50	4.50	5.00
ENR-4018-R68N	0.68	±30	0.026	0.020	4.90	5.60	3.30	3.80
ENR-4018-1R0N	1.00	±30	0.033	0.025	4.50	5.20	3.20	3.50
ENR-4018-1R5N	1.50	±30	0.039	0.030	3.35	4.00	3.00	3.20
ENR-4018-1R8N	1.80	±30	0.044	0.034	3.00	3.40	2.60	2.80
ENR-4018-2R2M	2.2	±20	0.059	0.045	2.70	3.20	2.40	2.60
ENR-4018-3R3M	3.3	±20	0.091	0.070	2.45	2.70	2.30	2.50
ENR-4018-4R7M	4.7	±20	0.117	0.090	2.20	2.30	2.00	2.20
ENR-4018-6R8M	6.8	±20	0.143	0.110	1.60	1.80	1.50	1.70
ENR-4018-100M	10	±20	0.234	0.180	1.30	1.60	1.00	1.20
ENR-4018-150M	15	±20	0.325	0.250	0.94	1.10	0.92	1.00
ENR-4018-220M	22	±20	0.468	0.350	0.80	0.88	0.80	0.95
ENR-4018-330M	33	±20	0.689	0.530	0.65	0.75	0.60	0.72
ENR-4018-470M	47	±20	0.845	0.650	0.57	0.70	0.50	0.65
ENR-4018-560M	56	±20	1.200	1.090	0.52	0.61	0.35	0.58
ENR-4018-680M	68	±20	1.300	1.160	0.45	0.55	0.35	0.50
ENR-4018-101M	100	±20	2.275	1.750	0.35	0.40	0.30	0.40
ENR-4018-151M	150	±20	3.250	2.500	0.31	0.34	0.25	0.36
ENR-4018-221M	220	±20	5.200	4.000	0.27	0.30	0.20	0.27
ENR-4018-331M	330	±20	6.045	4.650	0.27	0.29	0.17	0.24

Remark:

- ※1: All test data is referenced to 20°C ambient.
- ※2: R_{DC}: DC resistance at 20°C.
- ※3: Rated current: I_{SAT} or I_{RMS}, whichever is smaller.
- ※4: Saturation Current: max. Value, DC current at which the inductance drops less than 30% from its value without current;
typ. Value, DC current at which the inductance drops 30% from its value without current.
- ※5: Heat Rating Current: DC current that causes the temperature rise (ΔT) from 20°C ambient,
for max. Value, ΔT < 40°C; for typ. Value, ΔT is approximate 40°C.

苏州隆亿电子科技有限公司

SUZHOU LONGYI ELECTRONIC TECHNOLOGY CO.,LTD.

TEL: +86 512-66322495

<https://www.lyetec.com>

FAX: +86 512-68055173

E-mail: sales@lyetec.com

※6: Specifications subject to change without notice. Please check our website for latest information.

Packing specification

Carrier tape dimensions (mm)

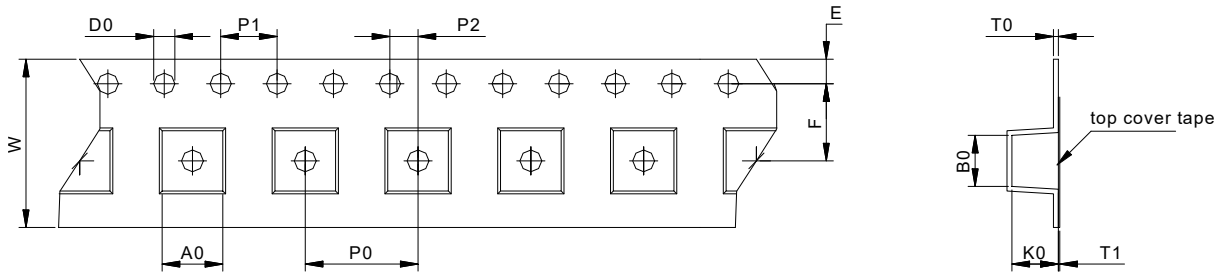

ITEM	W	P0	E	F	T0	T1	A0	B0	K0	D0	P1	P2
Size(mm)	12.0	8.00	1.75	5.50	0.40	0.10	4.30	4.30	3.30	1.50	4.00	2.00
Tolerance	±0.30	±0.10	±0.10	±0.10	ref.	max.	typ.	typ.	typ.	±0.10	±0.10	±0.10

Taping dimensions (mm)

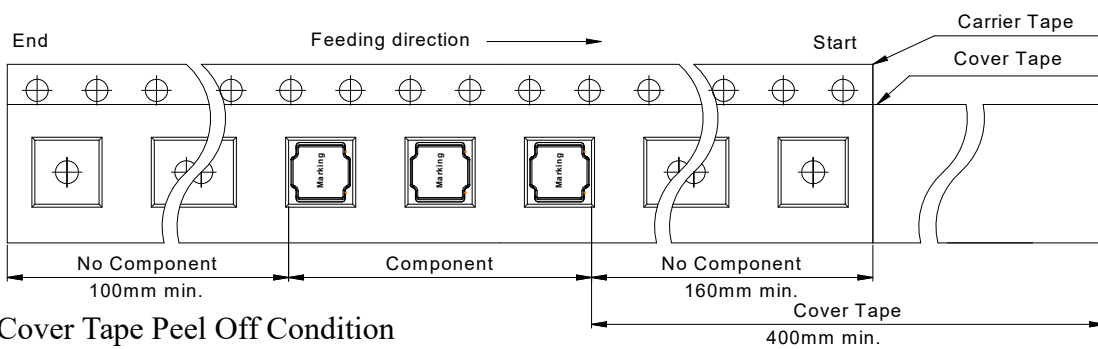

Cover Tape Peel Off Condition

Cover tape peel force shall be 10g to 130g.

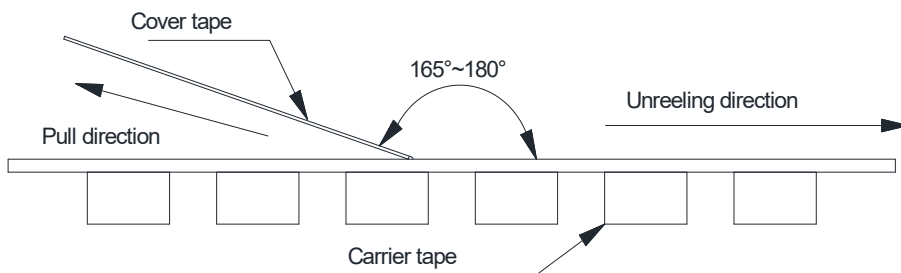

Reel Dimensions (mm)

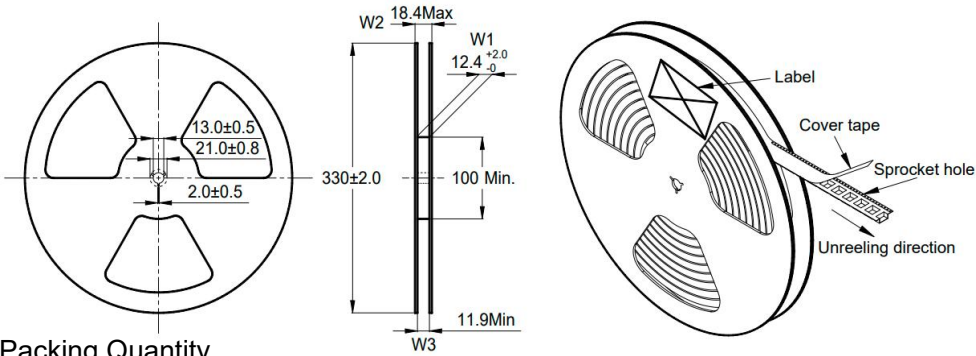

Packing Quantity

Product Series	Quantity/Reel	Inner Carton Quantity	Outer Carton Quantity
ENR-4018	3000pcs	(3000X4)=12000pcs	(12000X3)=36000pcs

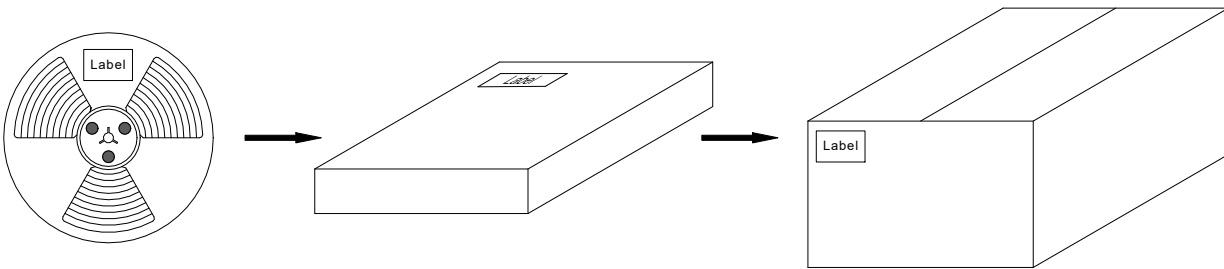

Recommended Soldering Conditions

Product can be applied to flow and reflow soldering.

(1) Flux, Solder

① Use rosin-based flux. Don't use highly acidic flux with halide content exceeding 0.2wt% (chlorine conversion value).

② Use Sn solder.

(2) Flow soldering conditions

① Pre-heating should be in such a way that the temperature difference between solder and product surface is limited to 150°C max. Cooling into solvent after soldering also should be in such a way that temperature difference is limited to 100°C max. Unwrought pre-heating may cause cracks on the product, resulting in the deterioration of products quality.

② Standard soldering profile.

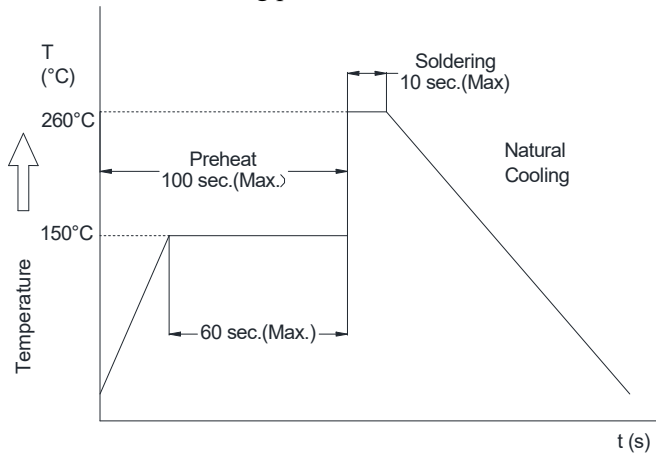

Pre-heating	150°C, 1 minute min
Peak	260°C, 10 seconds max

(3) Reflow soldering conditions

Classification Reflow Profile for SMT components:

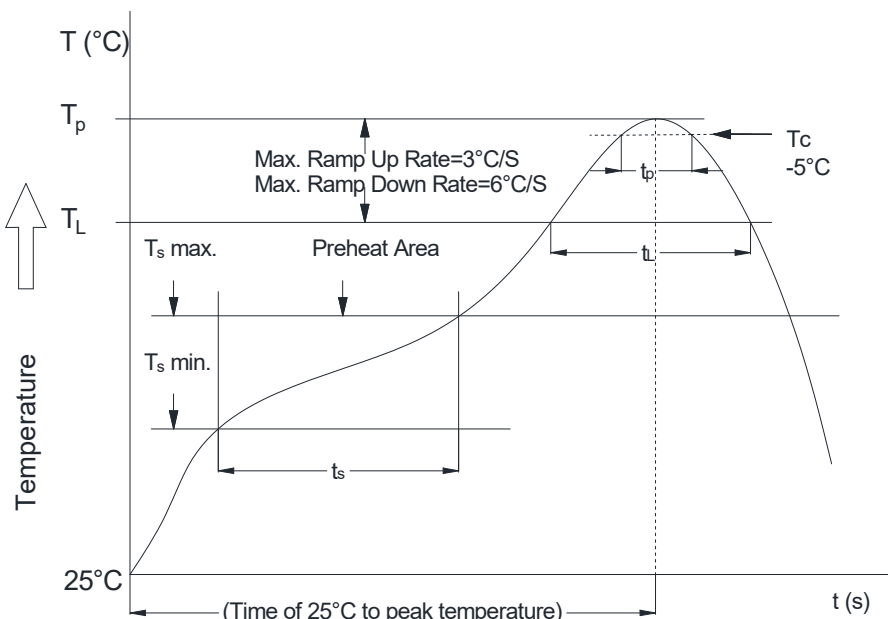

Classification Reflow Soldering Profile:

Profile Feature		Lead-Free Assembly
Average Ramp-Up Rate (Ts max. to Tp)		3°C/second max.
Preheat	- Temperature Min (Ts min.)	150°C
	- Temperature Max (Ts max.)	200°C
	- Time (Ts min to Ts max.)	60-120 seconds
Time maintained above	- Temperature (TL)	217°C
	- Time (tL)	60-150 seconds
Peak/Classification Temperature (Tp)		see table below
Peak/Classification Time (Tp)		3-4 seconds
Time within 5 °C of actual Peak Temperature (tp)		20-30 seconds
Ramp-Down Rate		6°C/second max.
Time 25 °C to Peak Temperature		8 minutes max.

Note 1: All temperatures refer to topside of the package, measured on the package body surface.

2: Refer to IPC/ JEDEC J-STD-020E

Package Classification Reflow Temperature:

Properties		Volume mm ³ <350	Volume mm ³ 350-2000	Volume mm ³ >2000
PB-Free Assembly	Package Thickness < 1.6 mm	260°C	260°C	260°C
PB-Free Assembly	Package Thickness 1.6mm-2.5 mm	260°C	250°C	245°C
PB-Free Assembly	Package Thickness ≥2.5 mm	250°C	245°C	245°C

Refer to IPC/ JEDEC J-STD-020E

(4) The method on Re-work with using the iron:

The following conditions must be strictly followed when using a soldering iron

Pre-heating	150°C, 1 minute
Tip temperature	280°C max
Soldering iron output	20w max
End of soldering iron	φ1mm max
Soldering time	3 seconds max

Products Storage

(1) Storage period

Products which inspected in LYEC over 12 months ago should be examined and used, which can be confirmed with inspection No. marked on the container. Solderability should be checked if this period is exceeded.

(2) Storage conditions

Products should be storage in the warehouse on the following conditions:

Temperature: Less than 40°C

Humidity : Less than 75% relative and humidity

No rapid change on temperature and humidity

- (3) Don't keep products in corrosive gases such as sulfur, chlorine gas or acid, or it may cause oxidization of electrode, resulting in poor solderability.
- (4) Products should be storage on the palette for the prevention of the influence from humidity, dust and so on.
- (5) Products should be storage in the warehouse without heat shock, vibration, direct sunlight and so on.
- (6) Products should be storage under the airtight packaged condition.